



Werkzeugsortiment mit Werkstattwagen 132-teilig

146A

Art.No. 98830200
GTIN 4018754343294
Model 146A



Bezeichnung.

Werkzeugsortiment mit Werkstattwagen Nr.146A Schubl.7 anthrazit, RAL 7016
132tlg

Beschreibung.

Top-Feature Werkstattwagen 95/7 PRO

- dreistufiges Sicherheits-Konzept:
 1. Zentralverriegelung durch seitliches Zylinderschloss mit abklappbarem Schlüssel
 2. Einzelverriegelung verhindert unbeabsichtigtes Öffnen während der Fahrt
 3. Kippschutz - gleichzeitiges Herausziehen mehrerer Schubladen nicht möglich.
- Edelstahlgriff mit verstärkter Korpusanbindung
- umlaufender Rammschutz mit Aufpralldämpfung
- dicht verschweißte widerstandsfähige Arbeits- und Ablagefläche sowie Abschlussblende aus Edelstahl
- öl- und säurebeständige, kugelgeführte Leichtlaufräder (Rollen-D.125 mm) mit Fadenschutz zum Schutz der Lager vor Schmutz und Fäden, mit zwei Feststellbremsen
- Papierrollen- und Spraydosenhalterung inklusive
- 7 leicht herausnehmbare Schubladen (schwarz RAL 9005) mit Vollauszug und Kugelhäufigführung
- beidseitige Lochraster für Haken Nr. 8031-8041, z. B. für größere Werkzeuge
- ausrüstbar mit STAHLWILLE Standard- und TCS-Einlagen

Inhalt 132-teilig

21 Ringmaulschlüssel Nr.13: SW 6; 7; 8; 9; 10; 11; 12; 13; 14; 15; 16; 17; 18; 19; 20; 21; 22; 24; 27; 30; 32mm

5 Ratschen-Ringmaulschlüssel Nr.17: SW 8; 10; 13; 17; 19

1 Einmaulschlüssel, verstellbar Nr.4025 10, SW max.29mm

10 Steckschlüsseleinsätze 1/4" mit Sechskant Nr.40: 5; 5,5; 6; 7; 8; 9; 10; 11; 12; 13mm

1 Knarre 1/4" Nr. 415-2K L.117mm

1 Steckgriff 1/4" Nr. 400N L.150mm

2 Verlängerungen 1/4" Nr. 405/2 (L.54mm), Nr. 405/6 (L.150mm)

1 Kardangelenk 1/4" Nr. 407 L.37mm

1 Bit-Halter 1/4" Nr. 412 L.25mm

1 Bit-Halter 1/4" Nr.1200/1 L.72mm

5 Bit-Schraubendrehereinsätze 1/4" für Innensechskantschrauben SW 3; 4; 5; 6; 8mm

10 Bit-Schraubendrehereinsätze 1/4" für Innen TORX®-Schrauben T8; T9; T10; T15; T20; T25; T27; T30; T40; T45
18 Steckschlüsseinsätze 1/2" mit Sechskant Nr. 52: SW 10; 11; 12; 13; 14; 15; 16; 17; 18; 19; 20; 21; 22; 23; 24; 27; 30; 32mm
1 Knarre 1/2" Nr. 512-2K L.265,5mm
2 Verlängerungen 1/2" Nr. 509/3 (L.75mm), Nr. 509/5 (L.130mm)
1 Kardangelenk 1/2" Nr. 510 L.71mm
1 Kugelkopfwinkelschraubendreher-Satz m.Clip Nr.10767/9, 9-teilig: SW 1,5; 2; 2,5; 3; 4; 5; 6; 8; 10mm
1 Kugelkopfwinkelschraubendreher-Satz m.Clip Nr.10771/8, 8-teilig: T9; T10; T15; T20; T25; T27; T30; T40

1 Dreikant-Hohlschaber Nr.10670-2K 265MM L.265mm
1 Rundfeile Nr.12025-2K 210MM Hieb 2 L.210mm
1 Dreikantfeile Nr.12035-2K 210MM Hieb 2 L.210mm
1 Flachfeile Nr.12036-2K 260MM L.260mm
1 Metallsägebogen Nr.12050 L.465mm
1 Spachtel Nr.21481 Blatt-B.60mm
1 Drahtbürste Nr.12377 L.270mm 1K-Griff
1 Magnetheber Nr.12600 500 G Trgf.500g
1 Teleskop-Edelstahlspiegel Spiegel-D.32mm

1 Kombinationszange Nr.6501 5 180 L.180mm
1 Seitenschneider Nr.6600 5 160 L.160mm
1 Flachrundzange m.Schneide Nr.6529 5 200 gerade L.200mm
1 Flachrundzange m.Schneide Nr.6529 5 200 gebogen L.200mm
1 Sicherungsringzange f.Innenringe Nr.6543 6 001, J1 gerade L.140mm
1 Sicherungsringzange f.Innenringe Nr.6543 6 002, J2 gerade L.180mm
1 Sicherungsringzange f.Innenringe Nr.6545 6 001, A1 gerade L.140mm
1 Sicherungsringzange f.Innenringe Nr.6545 6 002, A2 gerade L.180mm
1 Abisolierzange Nr.6622 5 160 L.160mm 2K-Griff
1 Wasserpumpenzange Nr.6551 6 240 L.240mm

6 Schlitzschraubendreher DRALL+ Nr.4621: 0,4x2,5x80; 0,5x3,5x90; 0,6x4,0x100; 0,8x5,5x120; 1x6,5x140; 1,2x8,0x160mm
4 Kreuzschlitzschraubendreher DRALL+ Nr.4630: PH0; PH1; PH2; PH3
1 Nylonhammer Nr.10956N 32 Kopf-D.32mm L.280mm
1 Schlosserhammer Nr.10960 300 G 300g
3 Splinttreiber achtkantig Nr.108 Spitzen-D.2,5; 4; 6 mm | L.150mm
1 Körner achtkantig Nr.105 D.10mm | L.120mm
1 Flachmeißel Nr.102/150 Schneiden-B.18mm L.150mm
1 Reißnadel Nr.12321 L.250mm
1 Kabelmesser Klängen-L.90mm Nr.12320
1 Stahlmaßstab Nr.131010 L.300mm
1 Rollbandmaß Nr.12935/3 L.3m

Technische Zeichnung.

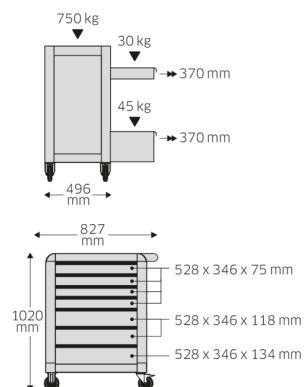

Technische Attribute.

Anzahl Schubladen	7
Anzahl Werkzeuge	132
Breite (mm)	827 mm
Farbe	anthrazit, RAL 7016
Höhe mm (h)	1020 mm
Länge (mm)	651 mm

Logistikdaten.

Code	98830200
Gewicht (brutto, kg)	0,000
Gewicht PAP (kg)	0,000
Gewicht PVC (kg)	0,000
GTIN	4018754343294
Packnorm	1
Ursprungsland	GERMANY
Ursprungsregion	Nordrhein-Westfalen
Zolltarifnr	82060000

Stückliste.



81200163
Werkstattwagen



72211000
Metallsägebogen



96432600
Kugelkopf-
Winkelschraubendrehe
r-Satz



96432700
Winkelschraubendrehe
r-Satz



65456102
Sicherungsringzange
f.Außenringe



31000000
Bit-Halter



13020000
Kardangelen



11180010
Bit-Halter



11020000
Kardangelen



65305200
Flachrundzange
m.Schneide



65295200
Flachrundzange
m.Schneide



77020000
Kabelmesser



77070000
Spachtel



77100000
Reißnadel



70050005
Körner



77090010
Drahtbürste



72173102
Flachfeile



72143100
Dreikantfeile



72123100
Rundfeile



72063103
Dreikant-Hohlschaber



77401032
Teleskop-
Edelstahlspiegel



77460001
Stahl-Maßstab

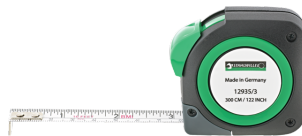

77040010
Rollbandmaß

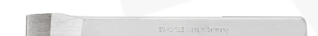

70020003
Flachmeißel



70070005
Splinttreiber



70070003
Splinttreiber



70070001
Splinttreiber



77260025
Magnetheber



70110010
Schlosserhammer



70171032
Nylonhammer



65516240
Wasserpumpenzange



65456001
Sicherungsringzange
f. Außenringe-



65436002
Sicherungsringzange
für Innenringe



65436001
Sicherungsringzange
für Innenringe



66005160
Seitenschneider



65015180
Kombinationszange

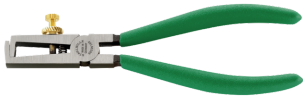

66226160
Abisolierzange



46303003
Kreuzschlitzschrauben
dreher DRALL+



46303002
Kreuzschlitzschrauben
dreher DRALL+



46303001
Kreuzschlitzschrauben
dreher DRALL+



46303000
Kreuzschlitzschrauben
dreher DRALL+



46213080
Schlitzschraubendrehe
r DRALL+



46213065
Schlitzschraubendrehe
r DRALL+



46213055
Schlitzschraubendrehe
r DRALL+



46213040
Schlitzschraubendrehe
r DRALL+



46213035
Schlitzschraubendrehe
r DRALL+



46213025
Schlitzschraubendrehe
r DRALL+



08130045
Bit-
Schraubendrehereinsat
z



08130040
Bit-
Schraubendrehereinsatz
z



08130030
Bit-
Schraubendrehereinsatz
z



08130027
Bit-
Schraubendrehereinsatz
z



08130025
Bit-
Schraubendrehereinsatz
z



08130020
Bit-
Schraubendrehereinsatz
z



08130015
Bit-
Schraubendrehereinsatz
z



08130010
Bit-
Schraubendrehereinsatz
z



08130009
Bit-
Schraubendrehereinsatz
z



08130008
Bit-
Schraubendrehereinsatz
z



08090008
Bit-
Schraubendrehereinsatz
z

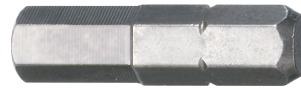

08090006
Bit-
Schraubendrehereinsatz
z

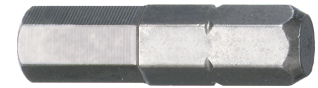

08090005
Bit-
Schraubendrehereinsatz
z



08090004
Bit-
Schraubendrehereinsatz
z

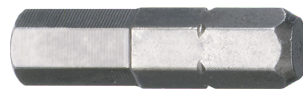

08090003
Bit-
Schraubendrehereinsatz
z



13111010
Knarre



11111010
Knarre



13010004
Steckschlüsselverlänge-
rung



13010002
Steckschlüsselverlänge-
rung



11010002
Steckschlüsselverlänge-
rung



11010001
Steckschlüsselverlänge-
rung



11050010
Steckgriff



01010055
Steckschlüsseinsatz



01010013
Steckschlüsseinsatz



01010012
Steckschlüsseinsatz



01010011
Steckschlüsseinsatz



01010010
Steckschlüsseinsatz



01010009
Steckschlüsseinsatz



01010008
Steckschlüsseinsatz



01010007
Steckschlüsseinsatz



01010006
Steckschlüsseinsatz



01010005
Steckschlüsseinsatz



03030032
Steckschlüsseinsatz



03030030
Steckschlüsseinsatz



03030027
Steckschlüsseinsatz



03030024
Steckschlüsseinsatz



03030023
Steckschlüsseinsatz



03030022
Steckschlüsseinsatz



03030021
Steckschlüsseinsatz



03030020
Steckschlüsseinsatz



03030019
Steckschlüsseinsatz



03030018
Steckschlüsseinsatz



03030017
Steckschlüsseinsatz



03030016
Steckschlüsseinsatz



03030015
Steckschlüsseinsatz



03030014
Steckschlüsseinsatz



03030013
Steckschlüsseinsatz



03030012
Steckschlüsseinsatz



03030011
Steckschlüsseinsatz



03030010
Steckschlüsseinsatz



40083232
Ringmaulschlüssel
OPEN BOX



40083030
Ringmaulschlüssel
OPEN BOX



40082727
Ringmaulschlüssel
OPEN BOX



40082424
Ringmaulschlüssel
OPEN BOX



40082222
Ringmaulschlüssel
OPEN BOX



40082121
Ringmaulschlüssel
OPEN BOX



40082020
Ringmaulschlüssel
OPEN BOX



40081919
Ringmaulschlüssel
OPEN BOX



40081818
Ringmaulschlüssel
OPEN BOX



40081717
Ringmaulschlüssel
OPEN BOX



40081616
Ringmaulschlüssel
OPEN BOX



40081515
Ringmaulschlüssel
OPEN BOX



40081414
Ringmaulschlüssel
OPEN BOX



40081313
Ringmaulschlüssel
OPEN BOX



40081212
Ringmaulschlüssel
OPEN BOX



40081111
Ringmaulschlüssel
OPEN BOX



40081010
Ringmaulschlüssel
OPEN BOX



40080909
Ringmaulschlüssel
OPEN BOX



40080808
Ringmaulschlüssel
OPEN BOX



40080707
Ringmaulschlüssel
OPEN BOX



40080606
Ringmaulschlüssel
OPEN BOX



40250110
Einmaulschlüssel
verstellbar



41171919
Ratschenringmaulschlüssel
OPEN RATCH



41171717
Ratschenringmaulschlüssel
OPEN RATCH



41171313
Ratschenringmaulschlüssel
OPEN RATCH



41171010
Ratschenringmaulschlüssel
OPEN RATCH



41170808
Ratschenringmaulschlüssel
OPEN RATCH



91100563
Verpackungsmaterial



91100541
Verpackungsmaterial

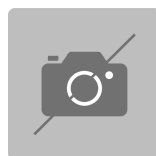

61005928
3/3 TCS-Einlage

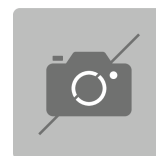

61005927
3/3 TCS-Einlage



61005926
3/3 TCS-Einlage



61005925
3/3 TCS-Einlage

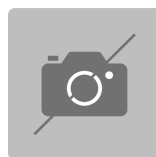

61005924
3/3 TCS-Einlage

Varianten.

Code	Artikelnr (ERP)	Bezeichnung	GTIN
98830200	146A	Werkzeugsortiment mit Werkstattwagen Nr.146A Schubl.7 anthrazit, RAL 7016 132tlg	4018754343294

GTIN-Code.



4 018754 343294

Bilder.

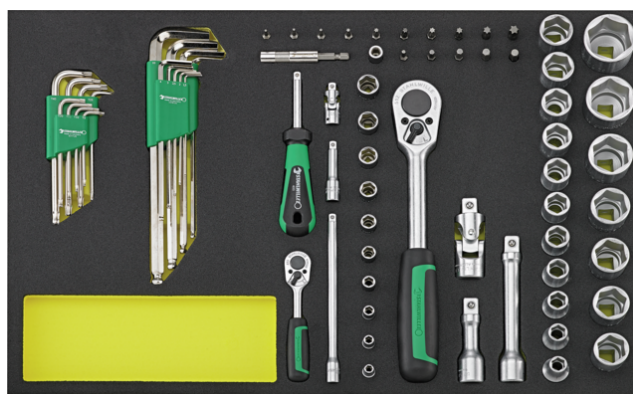
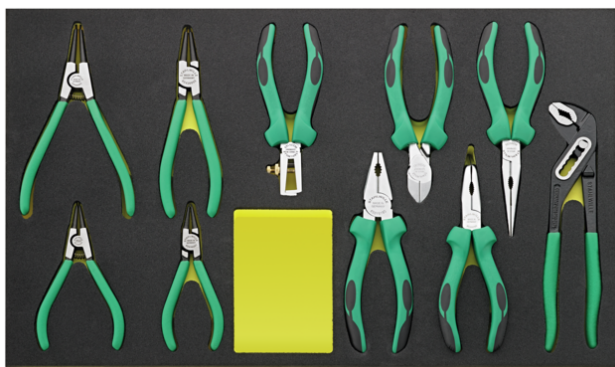

STAHLWILLE Eduard Wille GmbH & Co. KG

Lindenallee 27 · 42349 Wuppertal · Deutschland · Tel.: +49 202 4791-0 · Fax: +49 202 4791-200

info@stahlwille.de · www.stahlwille.de

Copyright by STAHLWILLE Eduard Wille GmbH & Co. KG, Wuppertal